

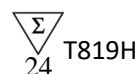

# Nucleic Acid Extraction Kit (For Viral DNA and RNA-Panall 8000)

## User Guide

Version 2.0



In-Vitro Diagnostics / For use with All-in-one Molecular Diagnosis System compatible with  
Viral DNA and RNA Extraction Kit



**Xi'an Tianlong Science and Technology Co., Ltd.**

No.4266, Shanglin Road, Weiyang District, Xi'an, 710021, Shaanxi, P.R. China



**SUNGO Europe B.V.**

Fascinatia Boulevard 522, Unit 1.7, 2909VA Capelle aan den IJssel, The Netherlands

# Contents

Intended Use.....	1
Product Performance Indicators.....	1
Special Notes.....	1
Testing Principle.....	1
Content of the Kit.....	2
Materials Required but not Provided .....	2
Warnings and Precautions .....	2
Precautions for Safe Handling.....	3
Reagent Storage and Handling.....	4
Sample Handling and Storage .....	4
Operation Guide.....	4
1. Automated Extraction Process.....	4
2. Operation Steps of Automated Extraction.....	5
2.1 Start up.....	5
2.2 Sample and Consumable Loading .....	5
2.3 Experimental Procedure run.....	8
2.4 Cleaning and maintenance of the instrument .....	10
Troubleshooting Guide .....	100
Quality Control.....	11
Limitations of Test Methods .....	11
Safety Symbols and Signs.....	11
Contact Information.....	11

Kit Version	2.0		
Changes	Address of Manufacturer Address of EU Representative Chapter "Content of the Kit" Chapter "Warnings and Precautions" Chapter "2. Operation Steps of Automated Extraction" Chapter "Limitations of Test Methods" Chapter "Safety Symbols and Signs" Chapter "Contact Information" Small lexical corrections.	Additions	Chapter "Precautions for Safe Handling"

## Intended Use

***Nucleic Acid Extraction Kit (For Viral DNA and RNA-Panall 8000)*** is designed to rapidly extract viral DNA and RNA from swab wash buffer. The extracted viral DNA and RNA are of high purity and stability and can be used in a variety of routine operations, including enzyme digestion, Polymerase Chain Reaction (PCR), DNA library constructions, Southern hybridization and blotting and other experiments.

***Nucleic Acid Extraction Kit (For Viral DNA and RNA-Panall 8000)*** is intended to be used by professional users, such as technicians and physicians who are trained in molecular biological techniques.

## Product Performance Indicators

The extraction kit can extract more than 100 copies/mL viral DNA nucleic acid, and more than 100 copies/mL viral RNA nucleic acid. Both the intra and inter-batch variations of the kit are less than 5%.

With instrument extraction, 1-8 samples can be operated at the same time, keeping the results stable and reproducible.

## Special Notes

***Nucleic Acid Extraction Kit (For Viral DNA and RNA-Panall 8000)*** is worked with TIANLONG® Panall 8000 All-in-one Molecular Diagnosis System (Panall 8000 MD System) that has been disinfected by UV light before use. After an experiment, wipe the inside of the extractor with 75% ethanol and disinfect with UV light for 15 minutes. An Panall 8000 All-in-one Molecular Diagnosis System automates the entire purification process can process 1-8 samples in a single run.

The kit is used to extract viral DNA and RNA targets. To avoid RNA degradation by RNase during operation, use exclusive-use utensils and sample injectors, and use disposable centrifuge tubes and tips processed by autoclave before using. The operator should wear powder-free gloves and a mask and protective coverall.

The kit has magnetic beads with a unique separation function and a unique buffer system to extract, isolate and purify high-quality nucleic acids from a variety of liquid samples such as swab wash buffer.

Magnetic beads enable the purification of high-quality nucleic acids that are free of protein, nuclease, and other impurities. Purified nucleic acids can be widely used in a variety of routine operations, including downstream experiments such as enzyme digestion, Polymerase Chain Reaction (PCR), DNA library construction, Southern hybridization and blotting.

Before attempting to install or use the product for the first time, please carefully read the manual's instructions, consider all possible consequences of miss operations or non-recommended functions, and pay special attention to the possible consequences.

## Testing Principle

***Nucleic Acid Extraction Kit (For Viral DNA and RNA-Panall 8000)*** is worked with TIANLONG® Panall 8000 All-in-one Molecular Diagnosis System (Panall 8000 MD System) designed by Xi'an Tianlong Science and Technology Co., Ltd. Magnetic beads are adsorbed, transferred and released using special magnetic rods based on the principle of magnetic bead adsorption. The extraction process enables the conduction of nucleic acid extraction and final adsorption of highly pure nucleic acids with the transfer of magnetic beads and nucleic acids.

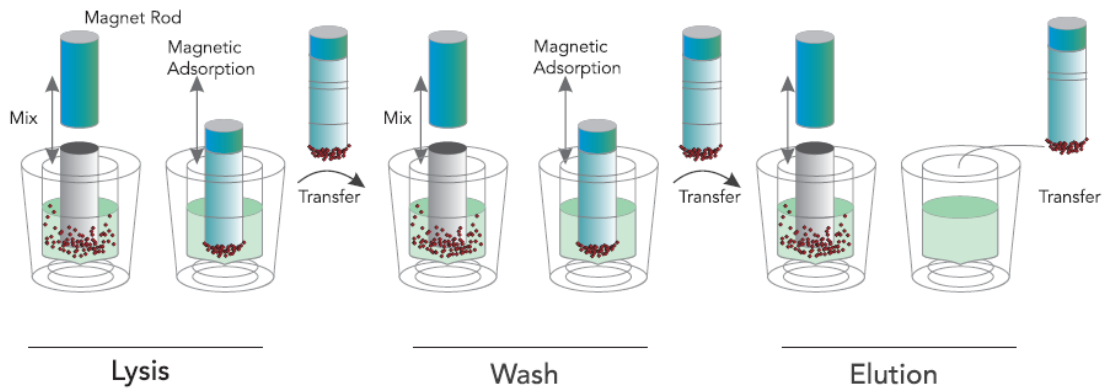

Figure 1. Schematic Diagram of Panall 8000 MD System

**An Panall 8000 All-in-one Molecular Diagnosis System (Panall 8000 MD System) performs the following steps on a sample containing magnetic particles:**

A magnetic rod protected by the mixing sleeve insert into a well which contains sample. The mixing sleeve stirs rapidly and repeatedly in the liquid to ensure complete mixing of the liquid and magnetic beads. After cell lysis, nucleic acid adsorption, washing and elution, high-purity nucleic acid is obtained.

Panall 8000 MD System equipped with a magnetic head that contains an array of 8 magnetic rods, allowing it to process up to 8 samples simultaneously.

**Content of the Kit**

Short Code		T819H
Name of Component		
REAG1	Size	24 T/Box
	Component	Pre-filled 24 Tubes
	Quantity	24
	Component Specification	1 Test

**Materials Required but not Provided**

When working in a laboratory, make sure to wear a proper lab coat, powder-free disposable gloves and protective goggles. For more information, please consult the Safety Data Sheet (SDS) available from the product supplier.

- 75% ethanol
- Extractor

**Warnings and Precautions**

**Please be sure to read the precautions before using the kit.**

The kit is used to extract viral DNA and RNA targets. To avoid RNA degradation by RNase during operation, use exclusive-use utensils and sample injectors, and use disposable centrifuge tubes and tips processed by autoclave before using. The operator (researcher or clinical expert) should wear powder-free gloves and a mask and protective coverall.

Please read the manual carefully before using the kit, and strictly follow the manual throughout operation. The subjected clinical samples should be collected on a clean bench or in a biosafety cabin.

Before using TIANLONG® Panall 8000 All-in-one Molecular Diagnosis System (Panall 8000 MD System), it must be disinfected by UV light. After an experiment, wipe the inside of the extractor with 75% ethanol and disinfect it with UV light for 15 minutes.

Do not mix reagents from different batches and use the kit within the expiry date.

Dispose of all samples and reagent materials used in an experiment, and clean and disinfect the experimental work bench thoroughly.

The **Nucleic Acid Extraction Kit (For Viral DNA and RNA-Panall 8000)** is intended for in vitro diagnosis use.

When using kit, always wear a suitable lab coat, disposable gloves, and protective goggles. For more information, please consult the appropriate Material Safety Data Sheets (MSDSs). These documents are available online in a convenient and compact PDF format at <https://www.ug-msds.com/MSDS1>, where the operator can find, view and print the appropriate MSDSs.

**⚠ Caution: Do not add any bleach or acidic solution directly to the pre-filled reagent.**

The pre-filled reagent contains guanidinium salts, which, when combined with bleach can form highly reactive compounds. If any of buffers are spilled, clean immediately with a suitable laboratory detergent and water. If the spilled liquid contains potentially infectious agents, clean the affected area with laboratory detergent and water first. And clean with sodium hypochlorite at a concentration of 1% (v/v). Be aware of following warnings and precautions while using the **Nucleic Acid Extraction Kit (For Viral DNA and RNA-Panall 8000)**.

Name of Component		Hazard pictograms (CLP)	Classification according to Regulation	Labelling according to Regulation
REAG 1	Lysis Buffer Washing Buffer A Washing Buffer B		Acute toxicity (oral), Category 4 Skin corrosion/irritation, Category 2 Serious eye damage/eye irritation, Category 2	<b>Hazard statements (CLP)</b> H302 - Harmful if swallowed. H315 - Causes skin irritation. H319 - Causes serious eye irritation. <b>Precautionary statements (CLP)</b> P264 - Wash hands, forearms and face thoroughly after handling. P280 - Wear protective gloves/protective clothing/eye protection/face protection/hearing protection. P321 - Specific treatment (see supplemental first aid instruction on this label). P337+P313 - If eye irritation persists: Get medical advice/attention. P501 - Dispose of contents/container to hazardous or special waste collection point, in accordance with local, regional, national and/or international regulation.
	Magnetic Beads Dilution Buffer Elution Buffer	None	None	None

Please see MSDS for more details.

### Precautions for Safe Handling

Do not dispose of the preparations or the packaging waste in drains leading to the sewage system or in the drainage system for waste not produced by industrial processing/analysis waste.

Any material in contact with reagents should be treated as a biological contaminant and treated in accordance with relevant local regulations.

## Reagent Storage and Handling

**Nucleic Acid Extraction Kit (For Viral DNA and RNA-Panall 8000)** should be stored at room temperature in a cool, dry and well-ventilated area. All components of the kit can be adequately store for up to 12 months.

The kit should be used in a well-ventilated area, and keep away from the source of heat, sparks, open flames and smoking.

To avoid evaporation, the pre-filled reagent should be used immediately after opening and should not be placed open for a long period of time.

Avoid exposure of the kit to UV light (e.g., for decontamination), which may result in accelerated aging.

## Sample Handling and Storage

Avoid foam formation inside or on the samples. Depending on the starting material, sample pre-treatment may be required. Samples should be stored at room temperature (25°C) before starting the experiment.

Samples should be used immediately after collection to extract nucleic acid or stored at 4°C for further experiment within 24 hours. For long-term storage, the samples should be placed at -20°C.

*For detailed information on sample pretreatment, please refer to 2.1.3.*

## Operation Guide

### 1. Automated Extraction Process

Panall 8000 All-in-one Molecular Diagnosis System (Panall 8000 MD System) enables nucleic acid extraction by magnetic beads. It uses magnetic rods to move the beads adsorbed with nucleic acid into different reagent well. Magnetic rod protected by the mixing sleeve which stirs rapidly and repeatedly in the liquid to ensure complete mixing of the liquid and magnetic beads. After cell lysis, nucleic acid adsorption, washing and elution, the high-purity nucleic acid is obtained. Panall 8000 All-in-one Molecular Diagnosis System (Panall 8000 MD System) are characterized by high automation, rapid extraction speed, stable results, and ease of operation. They are compatible with special reaction consumables and can process up to 1~8 samples concurrently.

The Panall 8000 All-in-one Molecular Diagnosis System (Panall 8000 MD System) can extract and purify nucleic acids from human samples using a variety of magnetic bead-based nucleic acid extraction reagents. All-in-one Molecular Diagnosis System have a wide range of applications in scientific research, clinical practice, disease control, food safety, forensics and other fields. The user needs to put sample tubes and the pre-packaged nucleic acid extraction into the instrument, All-in-one Molecular Diagnosis System then perform all nucleic acid extraction operations according to the experimental procedures.

The Panall 8000 All-in-one Molecular Diagnosis System (Panall 8000 MD System) is shown in Figure 2. Please refer to the user manual provided with an instrument for operating instructions.



Figure 2. Panall 8000 MD System

## 2. Operation Steps of Automated Extraction

### 2.1 Start Up

Turn on the power switch on the backside of All-in-one System. After 10 seconds, turn on the instrument switch on the instrument panel and the instrument starts to run with a short bleep.

After starting All-in-one System, the user could double click  on the desktop of the instrument touch screen to start the application software and All-in-one System will inspect and initialize the instrument by itself.

After the system self-inspection, the master screen automatically shows the login interface, as shown in figure 3. The user could enter the account in the <Username> box and the password in the <Password> box and click <Login> to login.

After login, the system will enter into the main interface, which is shown in Figure 4.

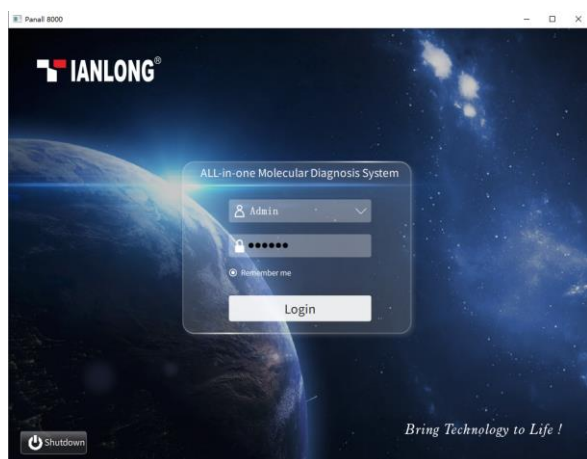

Figure 3. All-in-one System—Login Interface

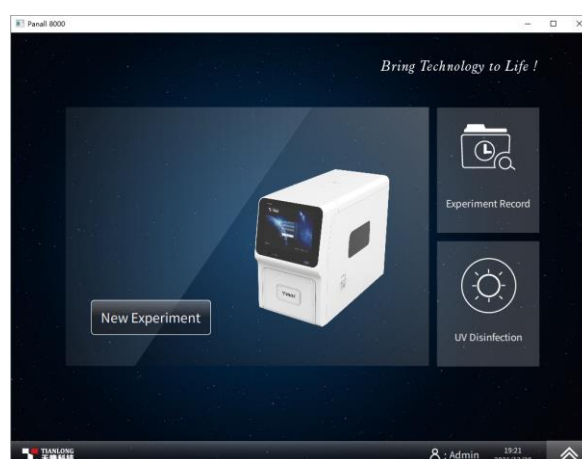

Figure 4. All-in-one System - Main Interface

### 2.2 Sample and Consumable Loading

Click <New Experiment> in the main interface and the system will enter into experiment preparation interface, which is shown in figure 5. Please select RAGE1 and PCR reaction reagents matched with the experiment type. Samples and Consumable are loaded correctly according to 2.2.1, 2.2.2 and 2.2.3.

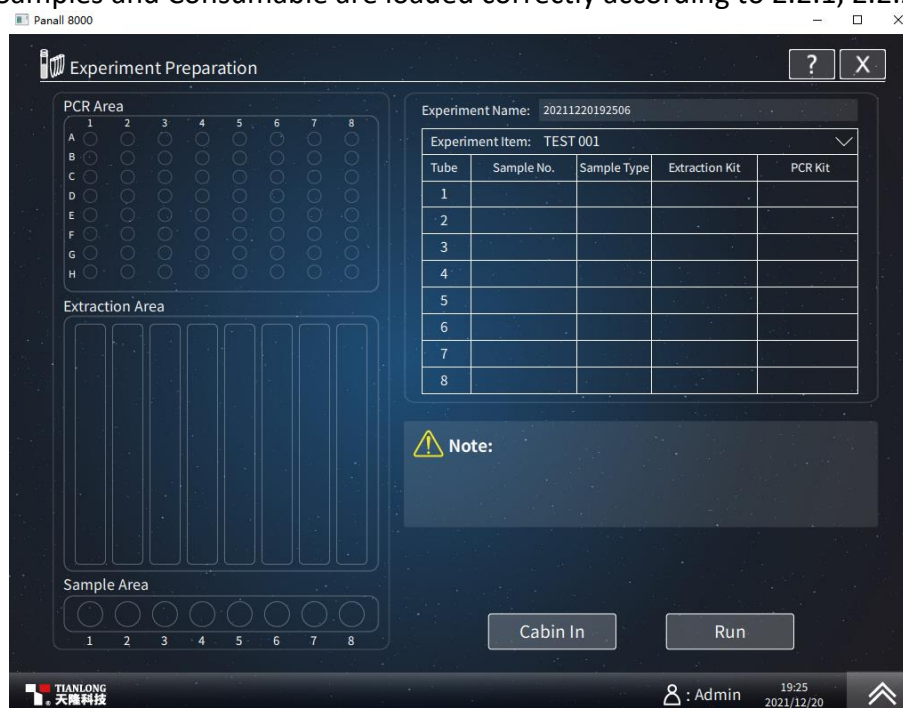

Figure 5. Experiment Preparation Interface

### 2.2.1 Sample Loading

Hold the sample tube with the barcode facing the scanning port for sample identification and the sample information is recorded into the software, which is shown in figure 6.

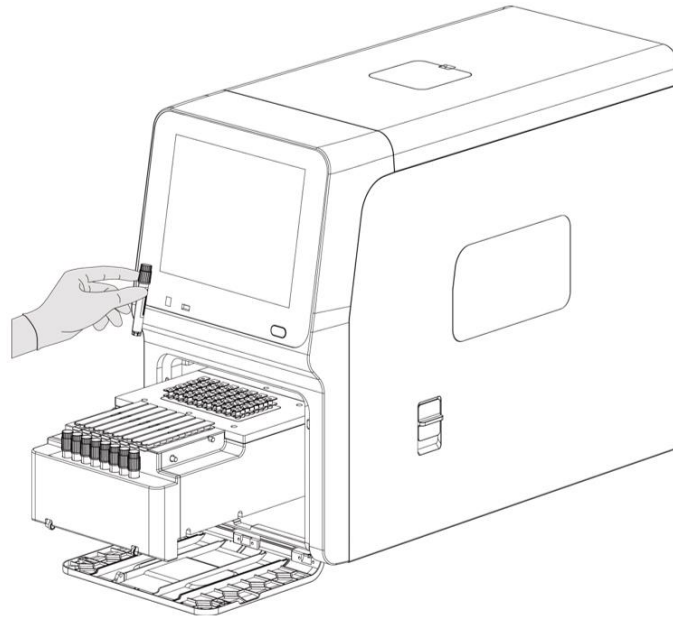

Figure 6. Sample Tube Barcode Scan

The loading area is with maximum capacity of 8 sample tubes. The user inserts the sample tube into the well after scanning, which is shown in figure 7.

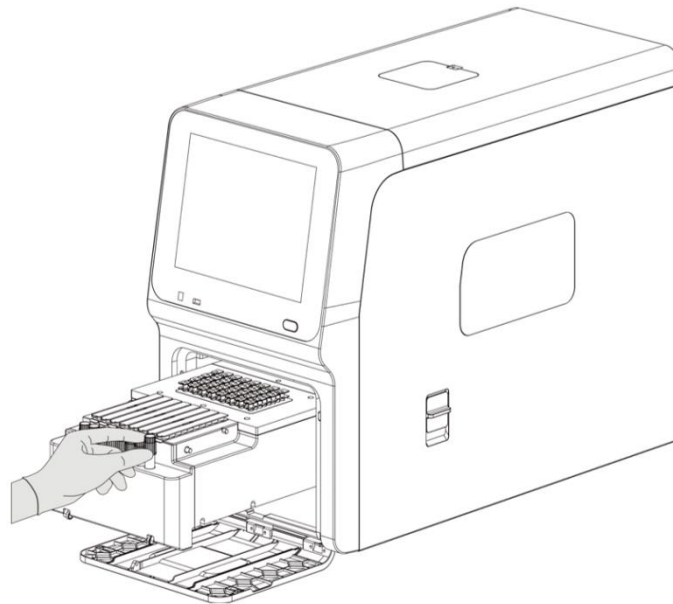

Figure 7. Sample Tube Loading

**⚠ Note:** The green light is on after loading the sample tube into the well. If the green light is not on, please confirm the sample tube is loaded properly. Insert sample tube into the well till the green light is on. Otherwise, it may indicate that sample loading is failed or the instrument is damaged.

**⚠ Caution:** Please ensure that the maximum sample volume doesn't exceed two thirds of the tube volume or it may cause the sample spill out leading to contaminating and damaging the instrument during loading the sample.



## 2.2.2 Load Nucleic Acid Extraction Consumables

The loading area is with maximum capacity of 8 sample tubes. Load the nucleic acid extraction consumables, to the same column of the extraction area on the sample tube loading position. The rod cover side of the nucleic acid extraction needs to be placed close to PCR reaction area, which is shown in figure8.

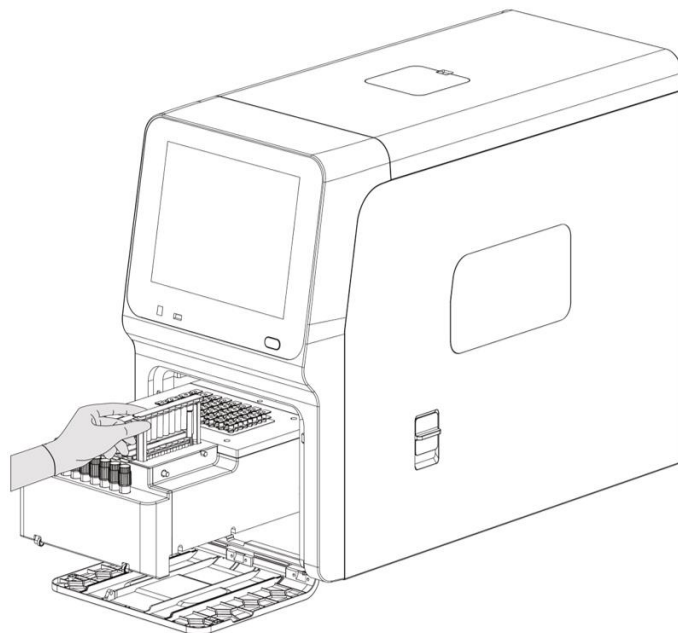

Figure 8. Nucleic Acid Extraction Consumables Loading

**⚠ Note: Before loading nucleic acid extraction consumables, its outer package should be removed. Please slightly swing or centrifuge the consumables to ensure the pre-aliquot reagent centers at the bottom so as to avoid there being lots of magnetic beads or reagents in the sidewall or seal.**

**⚠ Note: Please carefully check the extraction reagents type before loading them and ensure the barcode on the consumable is complete and clear so as to the instrument is able to read the reagent information.**

**⚠ Note: The consumable loading well in nucleic acid extraction area is designed as anti-misalignment. If the user does not load the consumable in the right direction, the consumable could not be placed into the well.**

## 2.2.3 Load PCR Reaction Consumable

The loading area is with a maximum capacity of 8 sample tubes. Load the PCR reaction consumables to the same column of the PCR reaction area following the loading position of the sample tube and the nucleic acid extraction consumables. The special tube side of PCR reaction consumables need to be placed close to the nucleic acid extraction area, which is shown in figure 9.

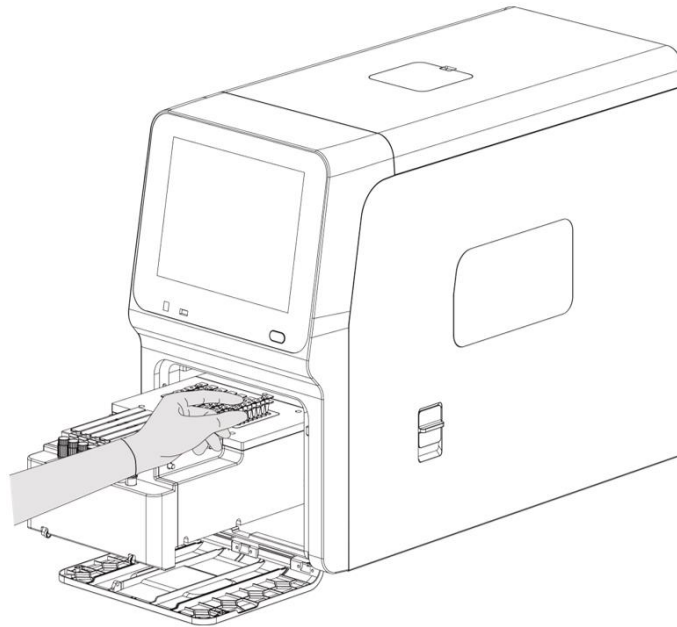

Figure 9. PCR Reaction Consumables Loading

**⚠ Note:** The consumable loading well in PCR reaction area is designed as anti-misalignment. If the user does not load the consumable in the right direction, the consumable could not be placed into the well.

**⚠ Note:** Please carefully check the PCR reaction reagents type before loading them and ensure the barcode on the consumable is complete and clear so as to the instrument is able to read the PCR reaction reagent information.

### 2.3 Experimental Procedure Run

The user could set the related experiment information of experiment name, experiment item, sample type, etc. The information of sample no., extraction reagent and amplification reagent is automatically displayed after scanning the barcode, which is shown in figure10.

Click <Experiment Name> box to enter an experiment name with character length edited as 1-32.

Click <Experiment Name> and select the experiment item to set from the dropdown list where shows all the experiment items loaded in the instrument.

The user could select any sample and click <Sample Type> to select the type as to-be-tested, positive and negative from the dropdown list.

Experiment Name: 20211220192506				
Experiment Item: TEST 001				
Tube	Sample No.	Sample Type	Extraction Kit	PCR Kit
1				
2				
3				
4				
5				
6				
7				
8				

Figure 10. Experiment Information Edit Area

The instrument automatically scans the consumable information after the user clicks <Run>. If nothing is abnormal, it will automatically enter into the experiment monitoring interface from the experiment preparation interface, which is shown in figure 11.



Figure 11. Experiment Monitoring Interface

The experiment monitoring interface displays the current experiment name and the experiment progress area displays the current experiment steps, including sample loading, nucleic acid extraction, pipetting and PCR reaction. The different colors of the light circle represent the different steps. The yellow blinking cursor means the experiment in this area is proceeding and the time in the middle means the remaining time of the experiment step.

Click <Stop> and Click <OK> to stop the experiment, which is shown in figure 12.

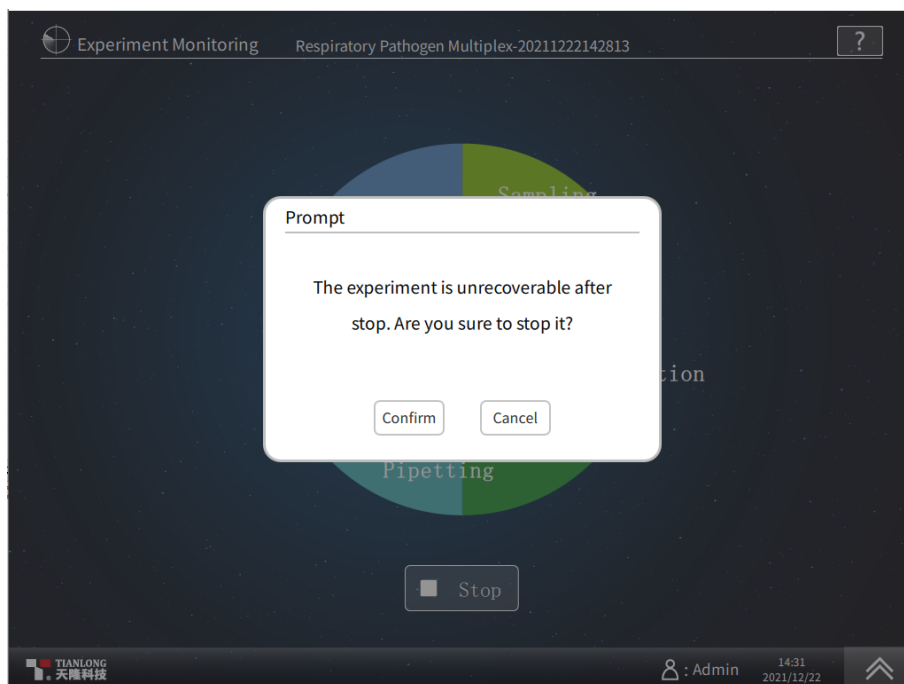

Figure 12. Stop Experiment

Click <Details> to check the detailed experiment running progress during the experiment running, which is shown in figure 13.

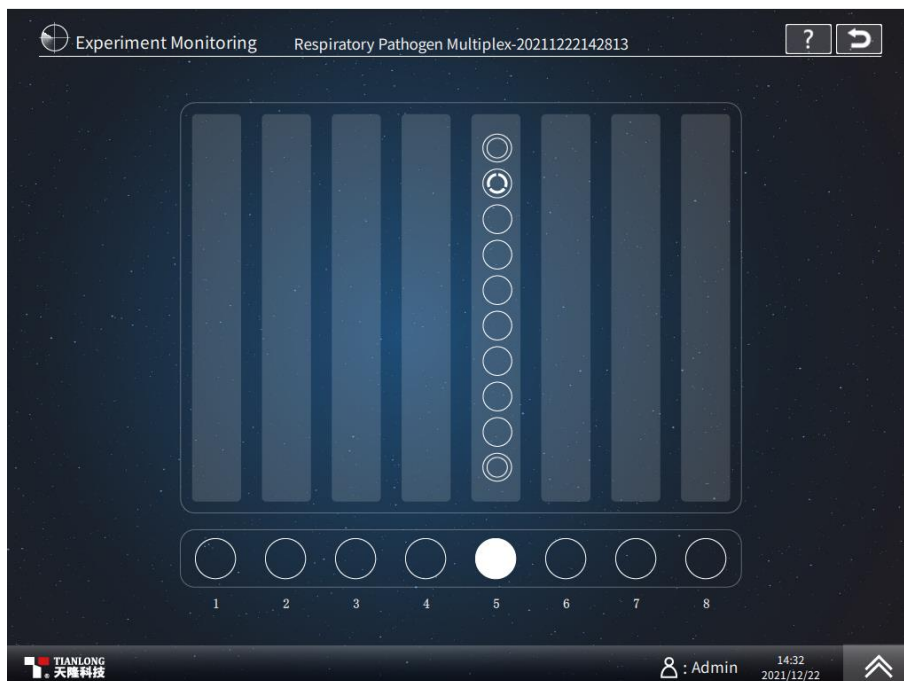

Figure 13. Details

**⚠ Note:** The user could click  on the top right corner of the experiment preparation interface to close this interface and also could click  on the top right corner to view the user manual.

After an experiment is run, the instrument will notify the user that the experiment is complete/over.

**⚠ Note:** If the user doesn't use the extracted product immediately, please store and seal it in a refrigerator at -20°C.

#### Disposal of medical wastes

Discard any used kits and wastes materials in accordance with local safety regulations. For the safety information, please see Page 6.

## 2.4 Cleaning and Maintenance of the Instrument

Follow the Cleaning and Maintenance of the Instrument in accordance with the user manual provided with the equipment. Ensure that the experimental chamber is cleaned regularly to minimize the risk of cross-contamination.

## Troubleshooting Guide

This troubleshooting guide should assist you in resolving any problems that arise during the experimental process. For more information, please visit our Technical Support Centre and Frequently Asked Questions, page at <http://www.medtl.net>. The scientists in our Tianlong company's Technical Services Department are always available to answer any questions you may have about the information and protocols contained in the manual, as well as sample and assay technologies (for contact information is included on the back cover or at <http://www.medtl.net>).

When an exception or error occurs during the experiment, the current run step is terminated/stopped. After resolving the error or exception, restart the run from the beginning. The troubleshooting guide is shown in the following table.

No.	Fault Symptom	Fault Cause	Handling Method
1	The amount of liquid in the reagent wells is insufficient	/	Contact the after-sales service of Tianlong.

2	Reagent consumables cannot be fully inserted into the instrument	The reagent consumables may be placed incorrectly.	Reposition the reagent consumables.
3	Reuse of pre-filled components	Please read the precautions in this manual before using the kit.	Re-extraction of nucleic acid is performed.
4	Poor extraction performance	Please follow the operation requirements in the manual.	Contact the Sales-Support Service team of Tianlong.
		The temperature control components of the instrument may be abnormal.	Contact the Sales-Support Service team of Tianlong.
		Other	Contact the Sales-Support Service team of Tianlong.

\* Ensure that the reagents have been preserved and used according to the manufacturer's instructions.

## Quality Control

In accordance with Tianlong Company's ISO-certified Quality Management, each lot of Viral DNA and RNA Extraction Kit is tested against predetermined specifications to ensure consistent product quality.

## Limitations of Test Methods





The system performance has been established through performance evaluation studies using swab wash buffers to purify viral DNA and RNA.











It is the user's responsibility to validate system performance for any procedures used in their laboratory that are not covered by the performance evaluation studies of Xi'an Tianlong Science and Technology Co., Ltd.

Although the kit is intended for use in public health and scientific research, the purity and quality of extraction results are also affected by the testing instruments and personnel. Moreover, the kit uses a specially formulated eluent that can affect the absorbance value, so it is not recommended to use a UV rays spectrophotometer to measure the extraction effect directly.

The extraction kit is intended for use with clinical diagnostic samples, forensic materials, and scientific research samples. The instrument and operator have an effect on the concentration and purity of the extracted product. Any generated diagnostic results must be interpreted in conjunction with the other clinical or laboratory findings.

## Safety Symbols and Signs

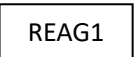
No.	Symbol	Implication
1		Catalogue number
2		Batch code
3	 <N>	Contains sufficient for <N> tests
4		Use by date
5		Caution

6		Temperature limit
7		In vitro diagnostic medical device
8		Reminder
9		Manufacturer
10		Do not re-use
11		Conformed with EU standard
12		Authorized representative in the European Community
13		Content of the kit
14		Pre-filled 10 strip tube
15		Warning
16		PAP21: Not-corrugated cardboard

## Contact Information

For technical assistance and more information, please contact our Technical Support Center at +86-29-82682132 (Tel), +86-29-82216680 (Fax), [inquiry@medtl.com](mailto:inquiry@medtl.com) or contact your local distributor.

For a patient/user/third party in the European Union and in countries with similar regulatory regime (Regulation 2017/746/EU on IVD Medical Devices); if, during the use of this device or as a result of its use, a serious incident has occurred, please report it to the manufacturer and/or its authorised representative and to your national regulatory authority.

For up-to-date licensing information or product-specific disclaimers, please see the respective User Guide. Tianlong User Guides are available at [www.medtl.net](http://www.medtl.net) or can be requested from Tianlong Technical Services or the local distributor.

IFU\_T819H\_EN © 2024 Xi'an Tianlong Science and Technology Co., Ltd., all rights reserved.